

Secondary Structure: Group I intron

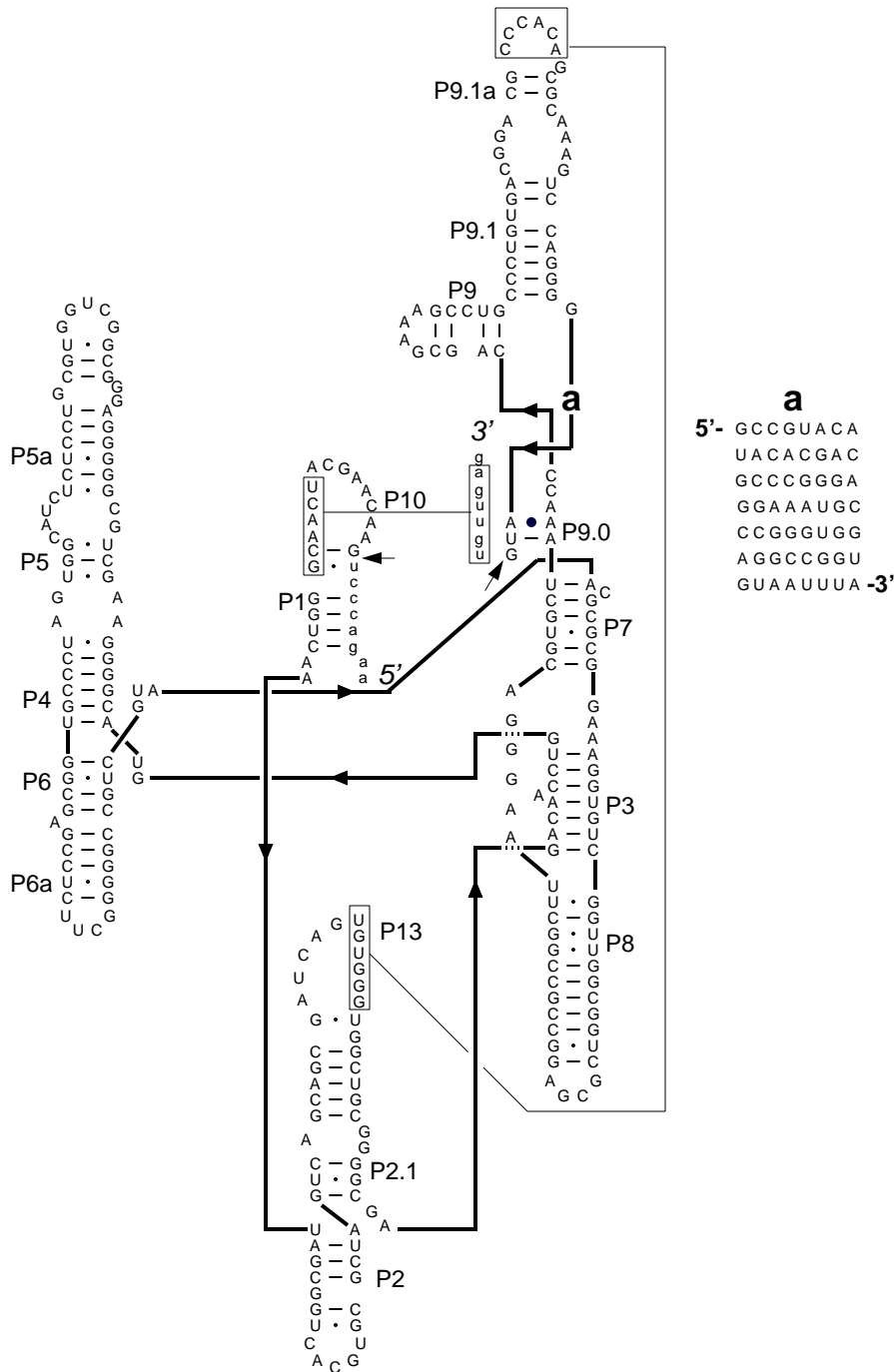

Metarhizium anisopliae var. *anisopliae*: Nuclear LSU rRNA [i2, 2066]

(AF197123) (IE)

1.cellular organisms 2.Eukaryota 3.eukaryote crown group

4.Fungi/Metazoa group 5.Fungi 6.Ascomycota

7.anamorphic Ascomycota 8.Metarhizium

9.Metarhizium anisopliae

May 2001